



MADE IN GERMANY



UNDERGROUND TECHNOLOGIES

---

TRENCHING





BETEK TUNGSTEN CARBIDE TOOLS



UNDERGROUND  
TECHNOLOGIES

- FOUNDATION DRILLING
- MINING
- TRENCHLESS
- TRENCHING
- TUNGSTUDS
- DRUM CUTTERS

IN USE WORLDWIDE



# TUNGSTEN CARBIDE AND STEEL

Steel and carbide are two materials with totally different expansion coefficients when subjected to heat. Nevertheless, it is of steel and tungsten carbide that our tools are made, with tungsten carbide for the wear-resistant tip, and steel for the tool shank. Since tools reach high temperatures during use, extreme tensile stresses are generated. These stresses are absorbed by a special brazing material that joins the tungsten carbide tip to the steel section.

We have developed our own methods and systems for this brazing process, which is carried out on fully automated machines with the process covered in an inert protective gas. Manufacturing parameters are fully monitored and documented to ensure consistent quality. Afterwards, brazing shear strengths are checked to ensure that our "Masters of the construction site" lose no time due to broken tools!



# BETEK HIGH-TECH TOOLS



1

## CUSTOMER SERVICE

- Efficient, customised solutions based on flexible structures
- Personalised, quick response to customer requirements



2

## DEVELOPMENT & CONSTRUCTION

- Quick creation of samples and prototypes
- Competitive pricing thanks to close cooperation with all production units



3

## TUNGSTEN CARBIDE MANUFACTURING

- High-purity raw materials are used for high strength
- Consistently high, pore-free tungsten carbide quality through precise process control thanks to years of experience and know-how



4

## SOLDERING PRODUCTION UNIT

Production facilities and processes specially developed to perfection by experts in the combination of tungsten carbide and steel





5

### AUTOMATION

Maintaining a competitive edge on the global market thanks to a high degree of automation and flexible manufacturing facilities



6

### QUALITY ASSURANCE

Continuous quality testing of the entire manufacturing chain all the way up to the installation site, in conformity with DIN ISO 9001:2000 and DIN EN ISO 14001



7

### TRAINING

User training courses at BETEK or on-site for sustainable, long-term commercial success and customer satisfaction



8

### LOGISTICS

Quick responses thanks to:

- the use of the very latest IT and enhanced logistics networking
- Standard products kept in stock

OUR KNOW-HOW COMBINED WITH STATE-OF-THE-ART PRODUCTION TECHNOLOGIES GUARANTEES THE FINEST QUALITY, MADE IN GERMANY







# WELD-ON TEETH

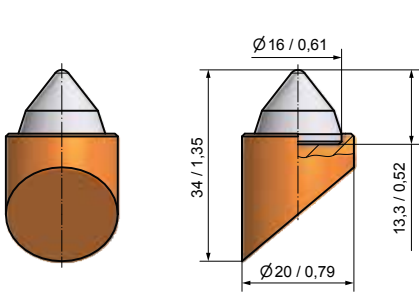

▪ **BFZ158**  
BFZ3 

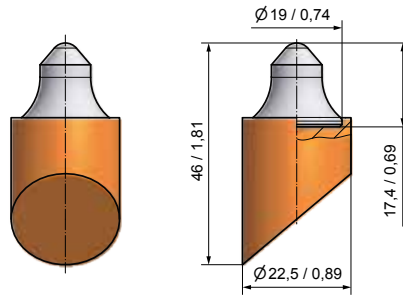

▪ **BFZ233**  
BFZ6 

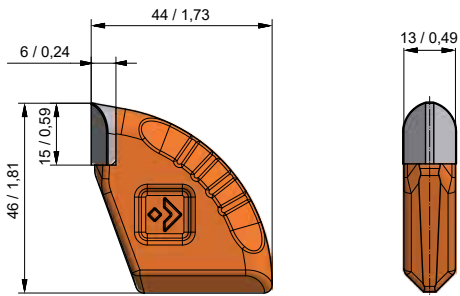

▪ **BFZ318**  
BFZ46x44x13 

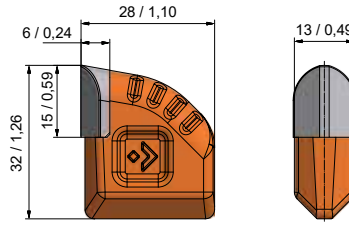

▪ **BFZ321**  
BFZ32x28x13 

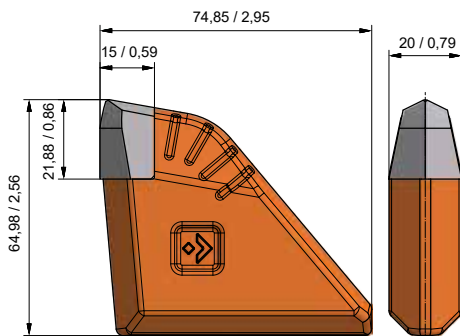

▪ **BFZ319**  
BFZ75x65x20 

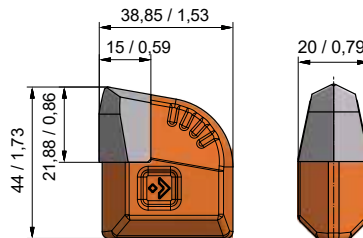

▪ **BFZ320**  
BFZ44x39x20 



# WELD-ON TEETH

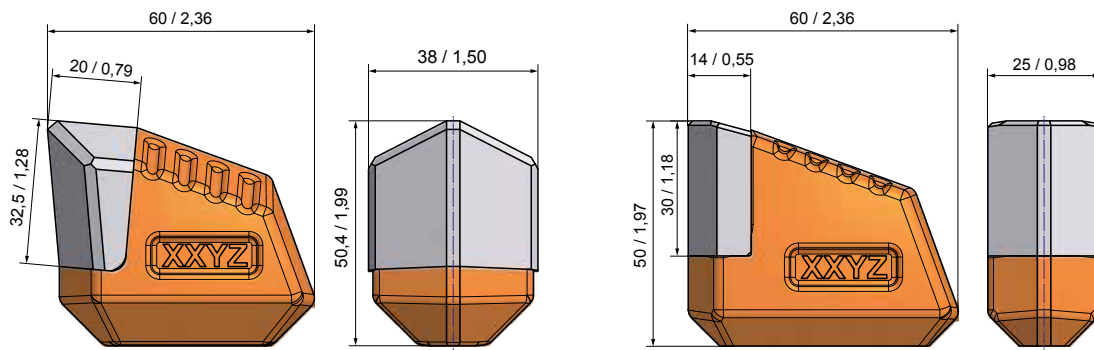

■ **BFZ326**  
BFZ38/M 

■ **BBM75**  
BBM25x50 



# ROUND SHANK CUTTER BITS

## ► SHANK SYSTEM – Ø 10,1 MM/0,40"

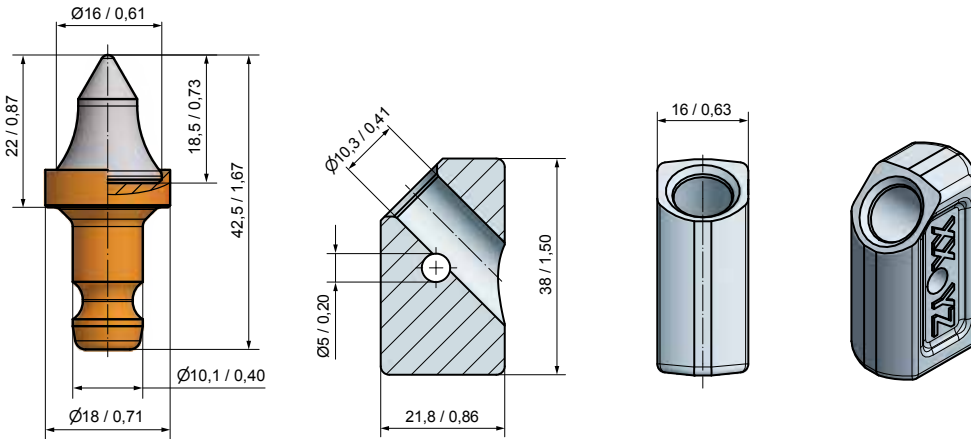

• **BM92**

BG10S-61.1822



• **BHR256**

B10.1645



## ► SHANK SYSTEM – Ø 11,2 MM/0,44"

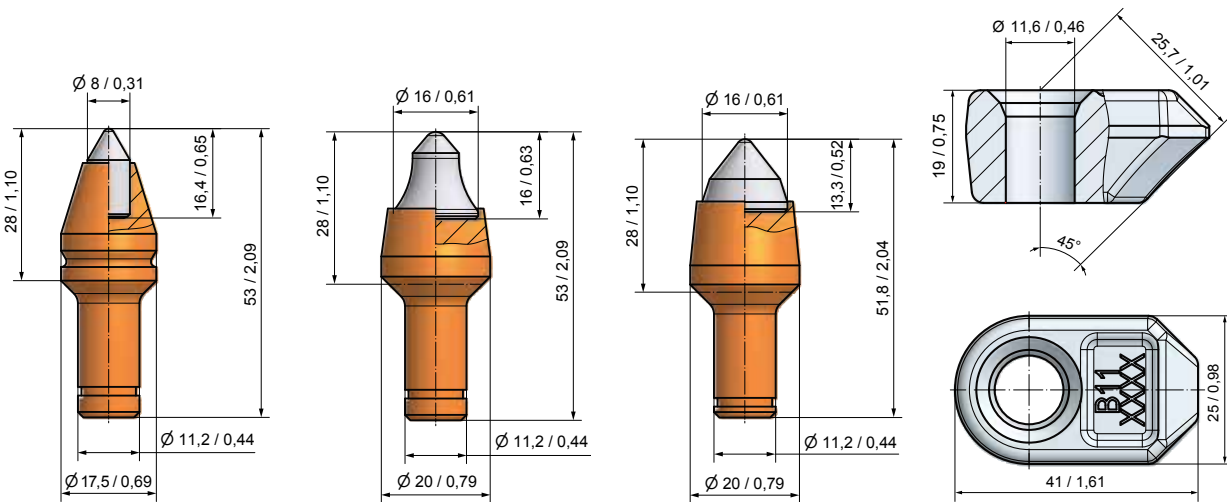

• **BM11**

BM8-11.3



• **BM10**

BG11W-61.2028



• **BM46**

BM3-11.3



• **BHR03**

B11





# ROUND SHANK CUTTER BITS



## > SHANK SYSTEM – Ø 14 MM/0,55"

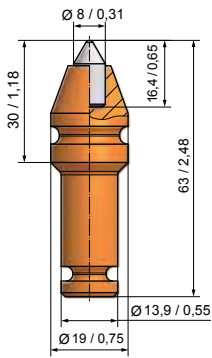

• **BM84**  
BG14X-08.1930

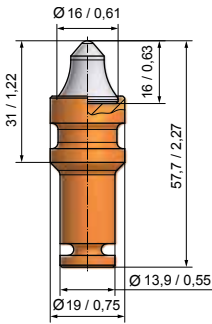

• **BM44**  
BM4-14

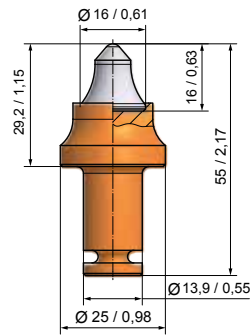

• **BM76**  
BG14X-61.2529

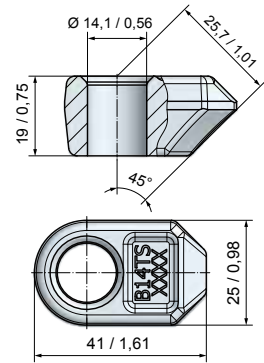

• **BHR171**  
B14TS



## > SHANK SYSTEM – Ø 14 MM/0,55"

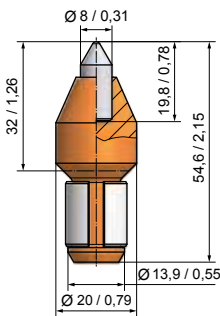

• **BM56**  
BM8-14/2

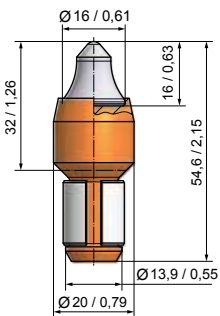

• **BM55**  
BG14H-61.2032

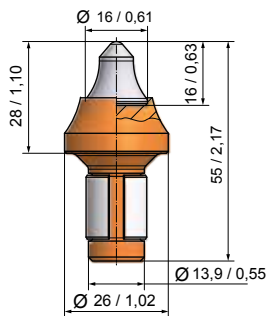

• **BM82**  
BG14H-61.2628

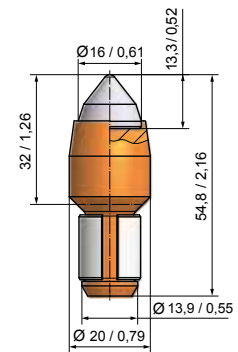

• **BM60**  
BM3-14/H

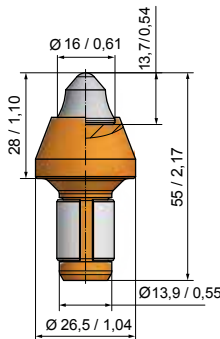

• **BM93**  
BG14H-61.2728

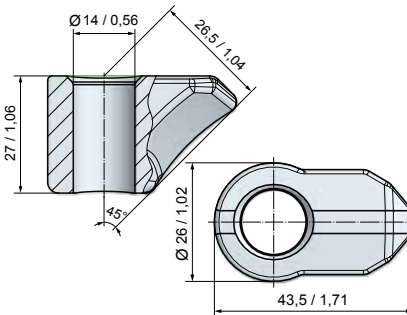

• **BHR109**  
B14

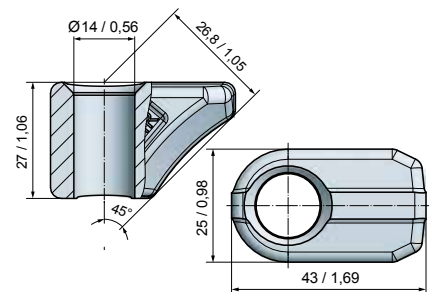

• **BHR260**  
B14.2545



► SHANK SYSTEM – Ø 18,7 MM/0,74"

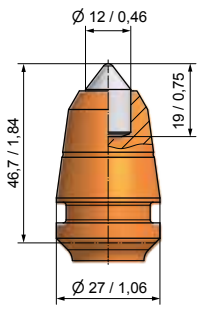
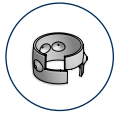

▪ **BTR02**  
B43HDK12 

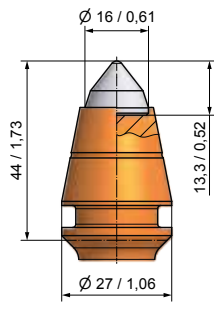

▪ **BTR03**  
B43/3 

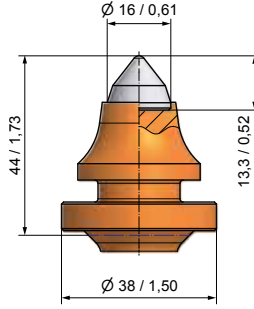

▪ **BTR09**  
BG19K-60.3844 

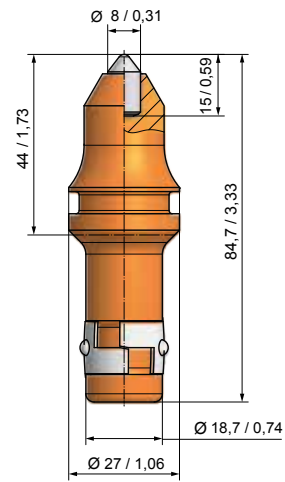

▪ **BTR01**  
B43K8 

► SHANK SYSTEM – Ø 18,7 MM/0,74"

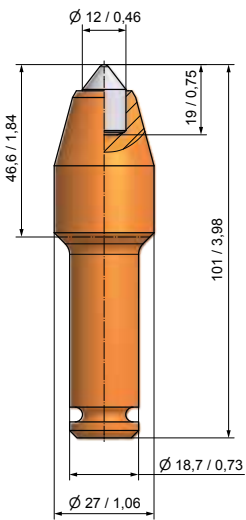

▪ **BTR07**  
B43K12KS 

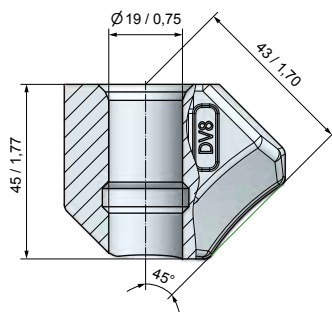

▪ **BHR20**  
DV8 

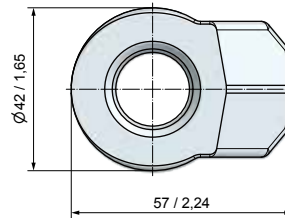



# ROUND SHANK CUTTER BITS



## ► SHANK SYSTEM – Ø 19,4 MM/0,76"

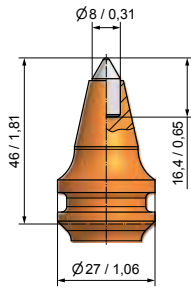

■ **BSK19**  
B1K8K 

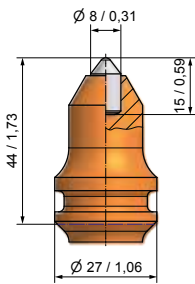

■ **BSK22**  
B1K8-K/2 

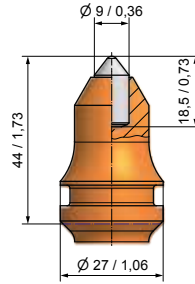

■ **BSK15**  
B1K9K 

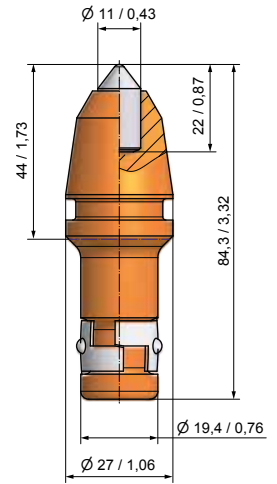

■ **BSK16**  
B1HDK11-K 

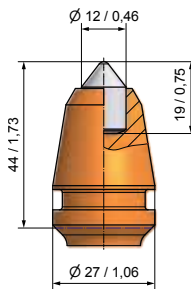

■ **BSK17**  
BG20K-12.2744 

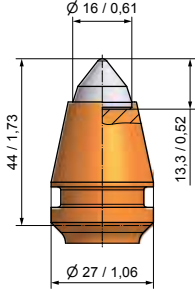

■ **BSK23**  
B3-K/2 

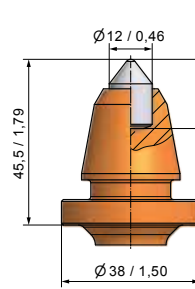

■ **BSK21**  
B1-12/38-K 



► SHANK SYSTEM – Ø 19,4 MM/0,76"

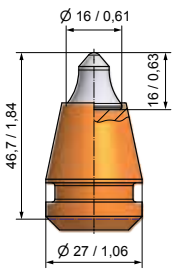

■ BSH204  
B4

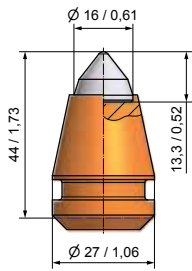

■ BSH09  
B3

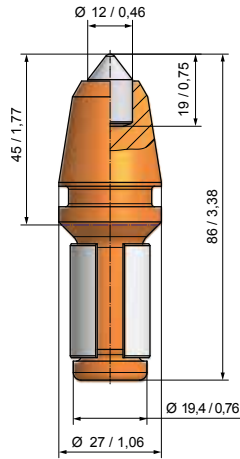

■ BSH05  
B1HDK12

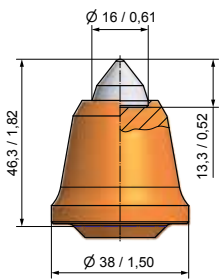

■ BSH211  
BG20H-60.3846

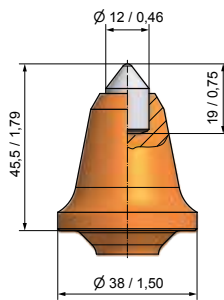

■ BSH210  
B1-12/38



► SHANK SYSTEM – Ø 19,4 MM/0,76"

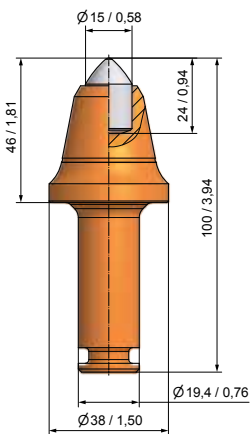

■ BC68  
BG20F-15.3846

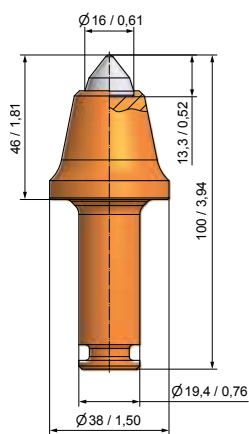

■ BC26  
B3KS

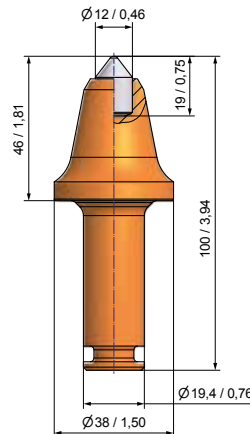

■ BC82  
BG20F-12.3846





# ROUND SHANK CUTTER BITS

## ► SHANK SYSTEM – Ø 19,4 MM/0,76"

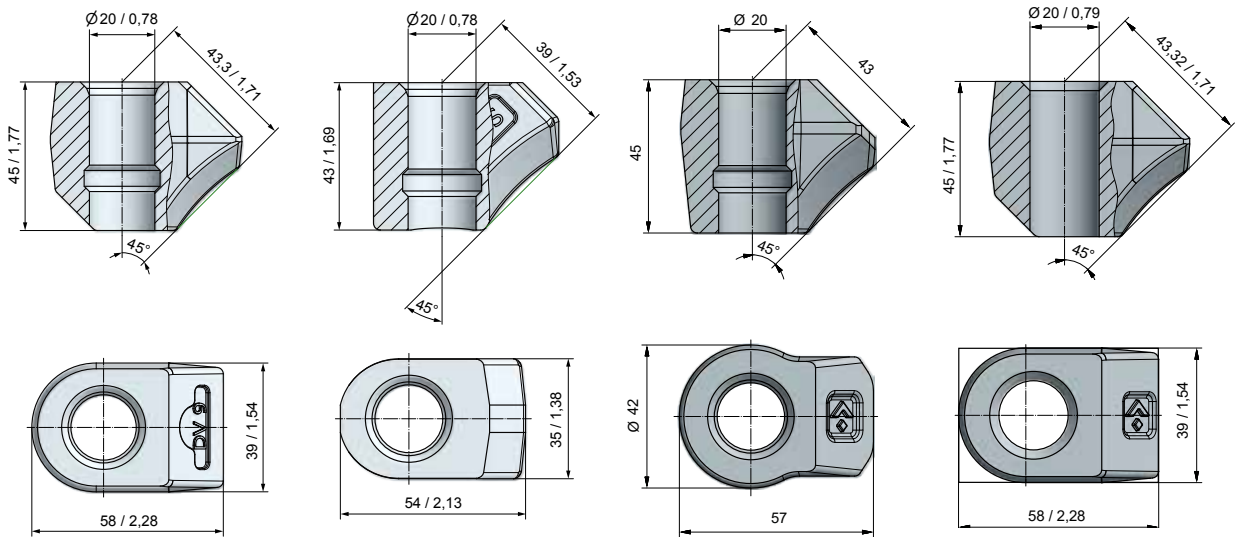

■ **BHR07**  
DV9



■ **BHR164**  
DV9-S



■ **BHR12**  
DV12



■ **BHR05**  
B10



► SHANK SYSTEM – Ø 22 MM/0,87"

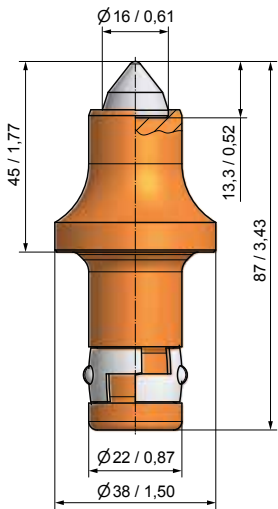
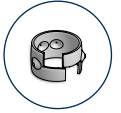

• **BC58**  
BG22K-60.3845

► SHANK SYSTEM – Ø 22 MM/0,87"

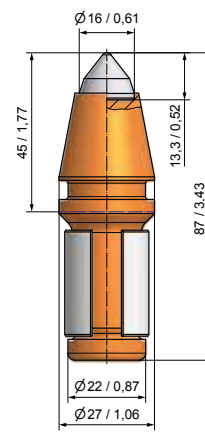
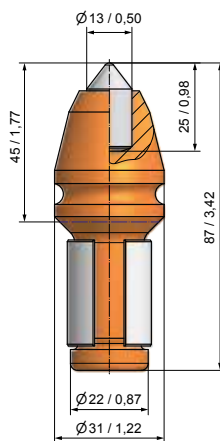
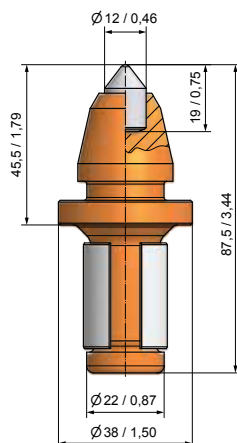
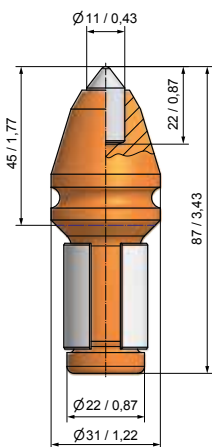
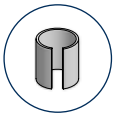

• **BC05**  
BG22H-11.3145

• **BC60**  
BG22H-12.3846

• **BC06**  
BG22G-13.3145

• **BC49**  
BG22H-60.2745



# ROUND SHANK CUTTER BITS



## ▶ SHANK SYSTEM – Ø 22 MM/0,87"

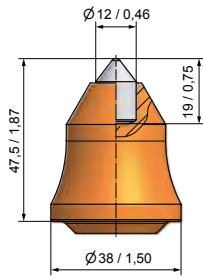

• **BC64**  
BG22H-12.3847

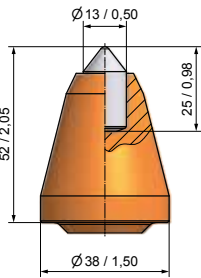

• **BC14**  
BG22H-13.3852

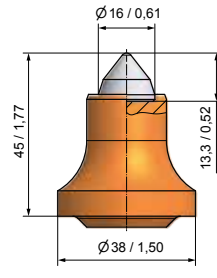

• **BC41**  
BG22H-60.3845

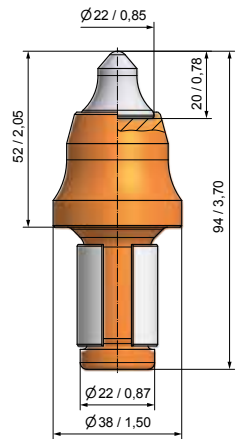

• **BC03**  
BG22H-67.3852

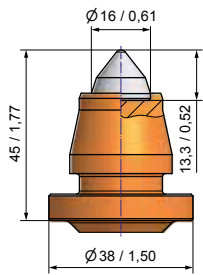

• **BC81**  
BG22H-60.3845

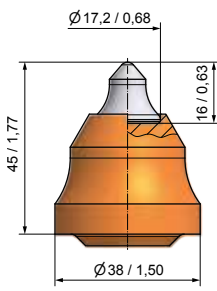

• **BC04**  
BG22H-62.3845

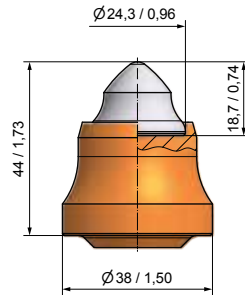

• **BC43**  
BG22H-68.3844



► SHANK SYSTEM – Ø 22 MM/0,87"

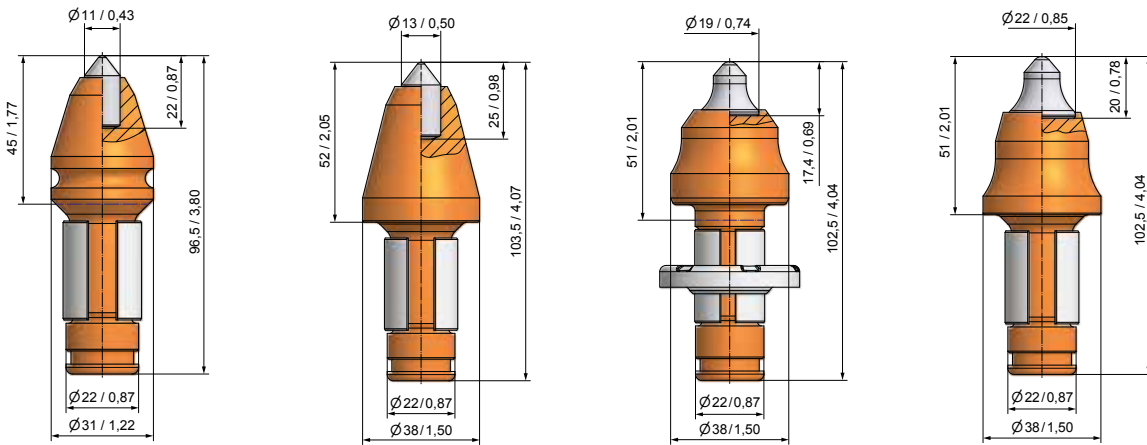

■ **BC01**  
BG22HW-11.3145



■ **BC15**  
BG22HW-13.3852



■ **BC61**  
BG22HW-63.4551



■ **BC44**  
BG22HW-67.3851



► SHANK SYSTEM – Ø 22 MM/0,87"

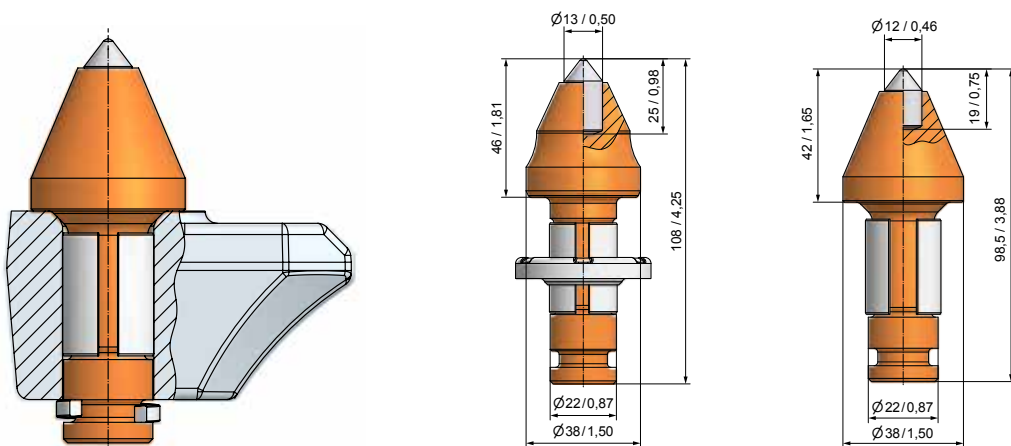

■ **BC79**  
BG22HF-13.4551



■ **BC36**  
BG22HF-12.3842





# ROUND SHANK CUTTER BITS



## ▶ SHANK SYSTEM – Ø 22 MM/0,87"

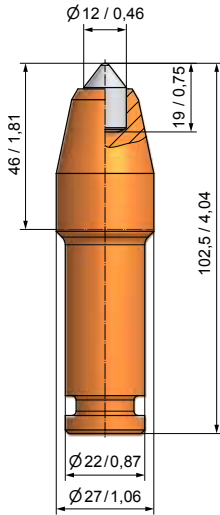

• **BC39**  
B1-12KS/22

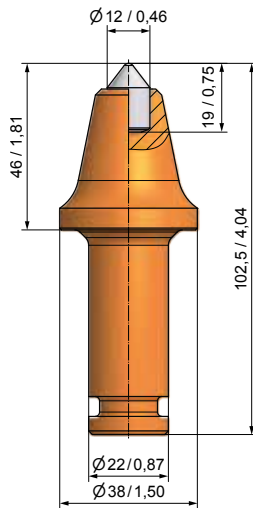

• **BC62**  
BG22F-12.3846

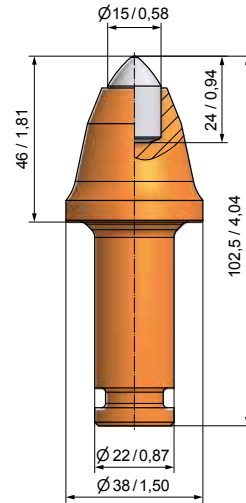

• **BC77**  
BG22F-15.3846

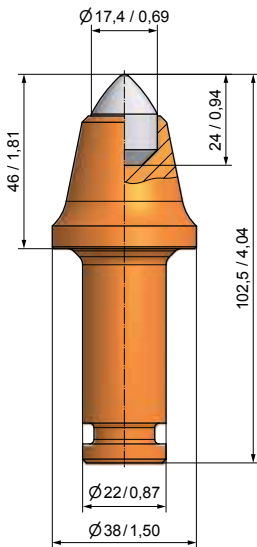

• **BC56**  
BG22F-17.3846

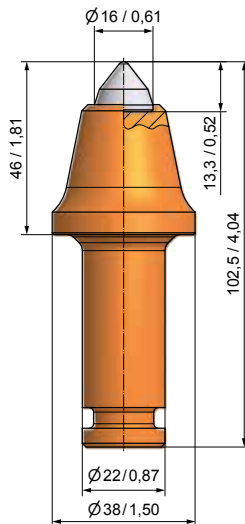

• **BC33**  
BG22F-60.3846

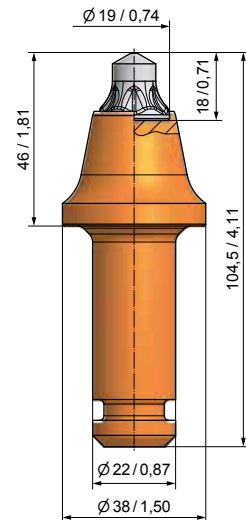

• **BC78**  
BG22F-65.3846



► SHANK SYSTEM – Ø 22 MM/0,87"

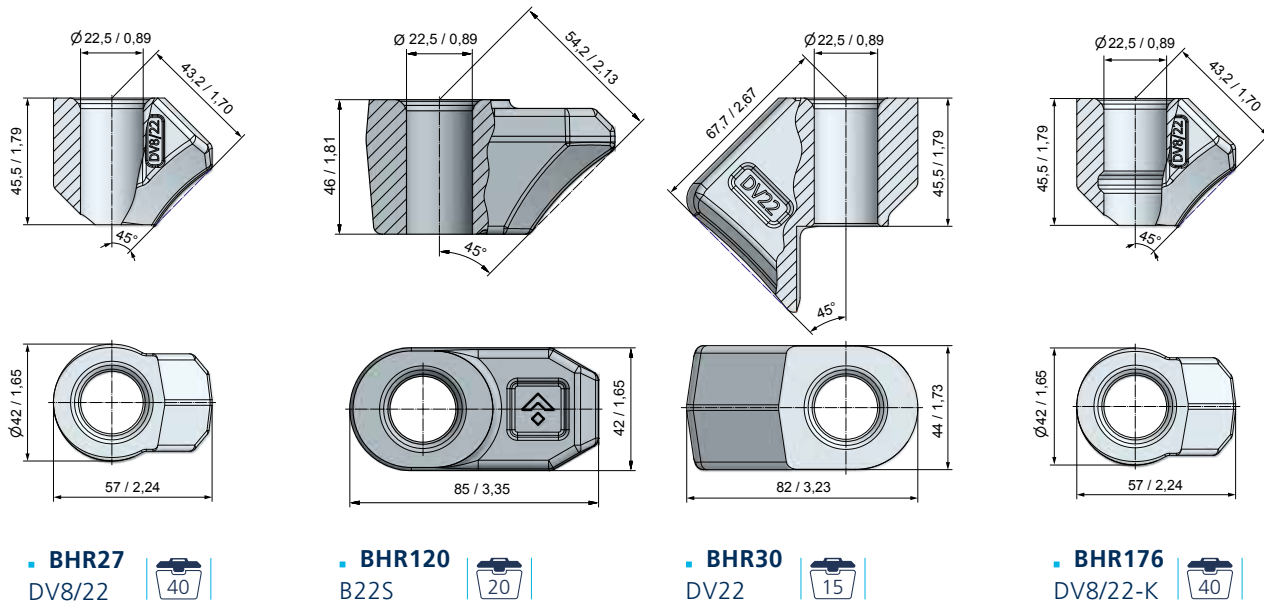



# ROUND SHANK CUTTER BITS



## ▶ SHANK SYSTEM – Ø 25 MM/1"

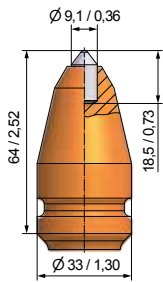

■ **BTK01**  
BG25-09.3364

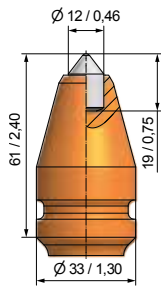

■ **BTK03**  
BG25K-12.3361

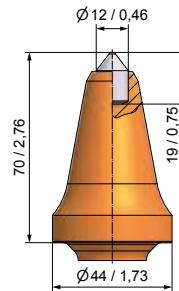

■ **BTK141**  
BG25K-12.4470A

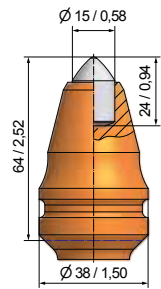

■ **BTK10**  
BG25K-15.3864

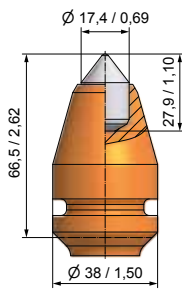

■ **BTK70**  
BG25K-17.3867

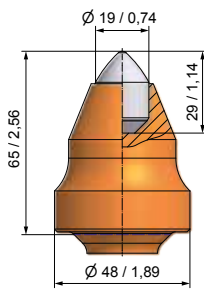

■ **BTK54**  
BG25K-19.4865

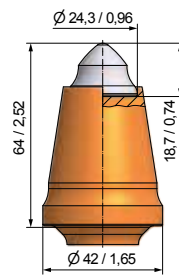

■ **BTK87**  
BG25K-68.4264

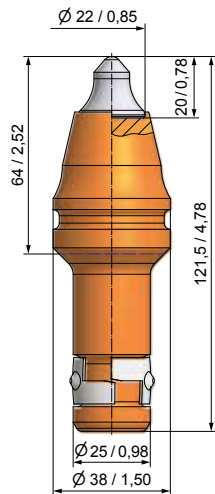

■ **BTK20**  
BG25K-67.3864

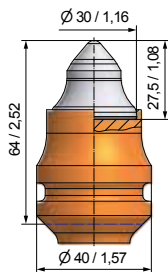

■ **BTK23**  
BG25K-69.4064

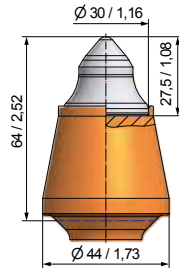

■ **BTK26**  
BG25K-69.4464

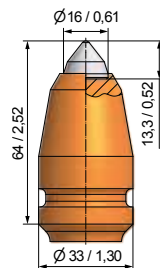

■ **BTK16**  
BG25K-60.3364











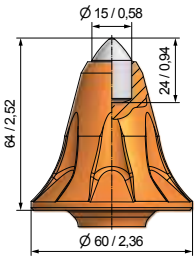
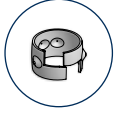

# ROUND SHANK CUTTER BITS

## ▶ SHANK SYSTEM – Ø 25 MM/1"



• **BTK81**  
B40HDS/60 

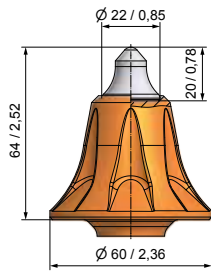

• **BTK80**  
B4022/60 

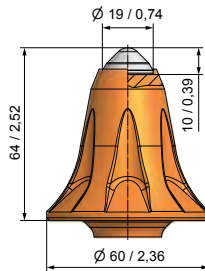

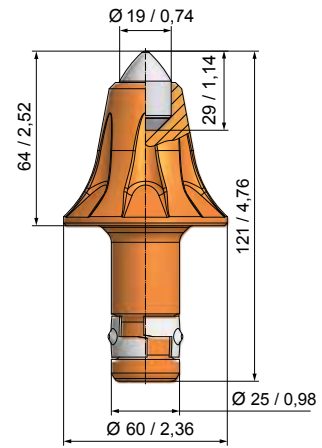

• **BTK82**  
B40SG/60 

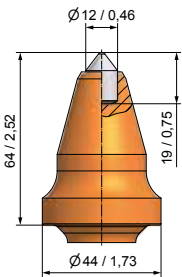

• **BTK89**  
BG25K-19.6064 

## ▶ SHANK SYSTEM – Ø 25 MM/1"



• **BTK142**  
BG25F-12.4464 

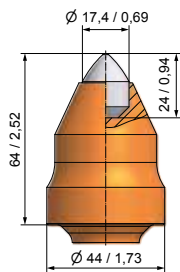

• **BTK11**  
BG25F-17.4464 

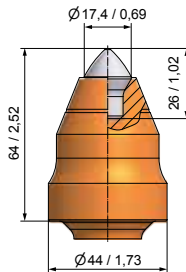

• **BTK135**  
BG25F-70.4464 

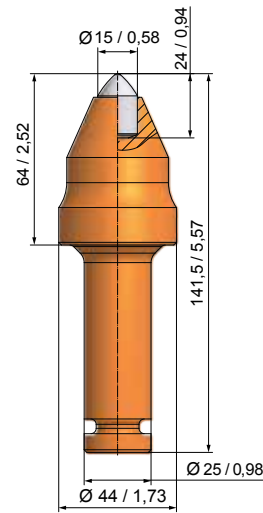

• **BTK29**  
BG25F-15.4464 

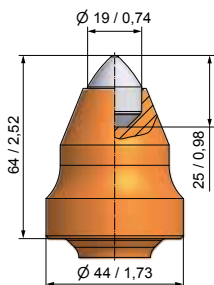

• **BTK14**  
BG25F-19.4464 

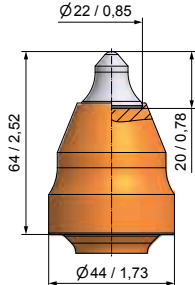

• **BTK43**  
BG25F-67.4464 

# ROUND SHANK CUTTER BITS



## ▶ SHANK SYSTEM – Ø 25 MM/1" GAUGE 64 MM/2,5"

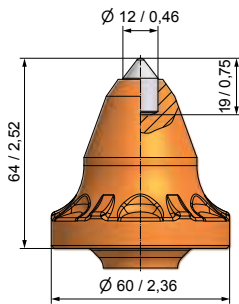

• **BTK114**  
BG25F-12.6064

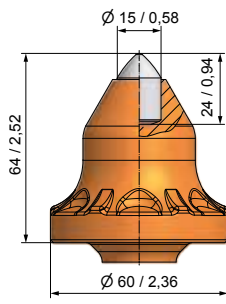

• **BTK120**  
BG25F-15.6064

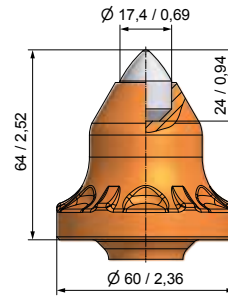

**BTK121**  
BG25F-17.6064

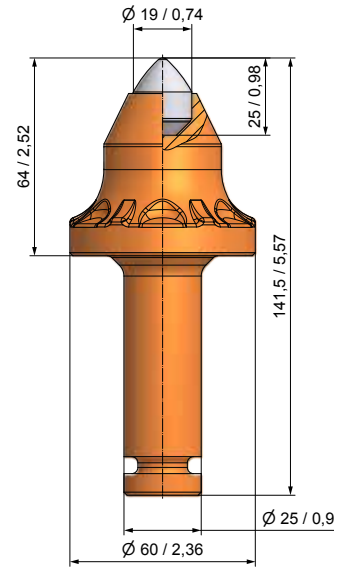

**BTK122**  
BG25F-19.6064

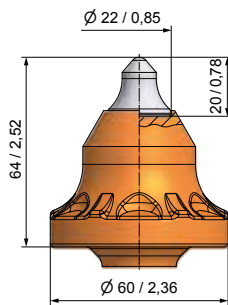

**BTK123**  
BG25F-67.6064

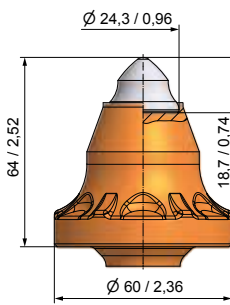

**BTK124**  
BG25F-68.6064

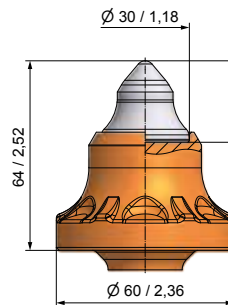

**BTK125**  
BG25F-69.6064A

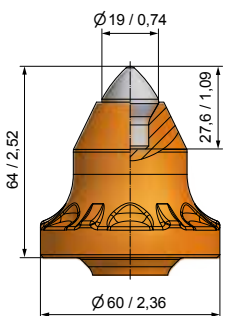

**BTK143**  
BG25F-72.6064

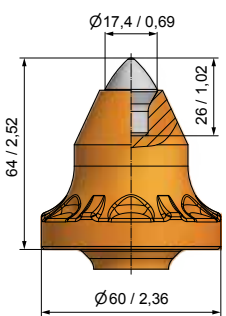

• **BTK150**  
BG25F-70.6064

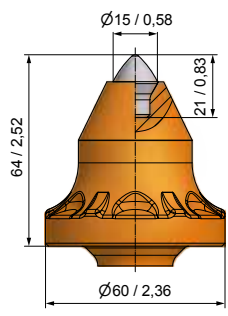

• **BTK151**  
BG25F-76.6064

► SHANK SYSTEM – Ø 25 MM/1"  
GAUGE 76 MM/3,0"

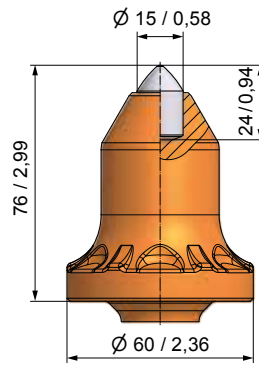
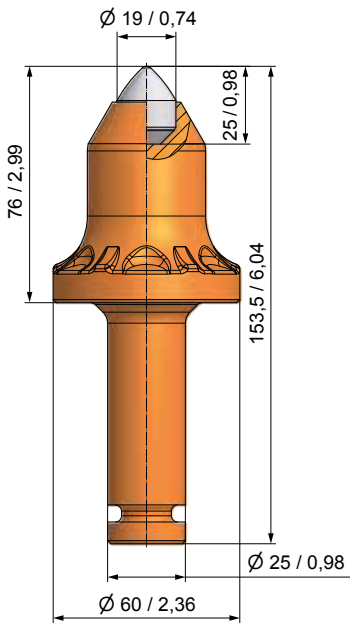

• **BTK113**  
BG25F-15.6076

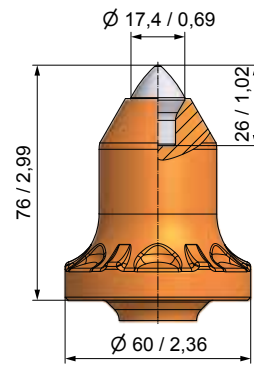

• **BTK126**  
BG25F-70.6076

• **BTK127**  
BG25F-19.6076





# ROUND SHANK CUTTER BITS

## > SHANK SYSTEM – Ø 25 MM/1"

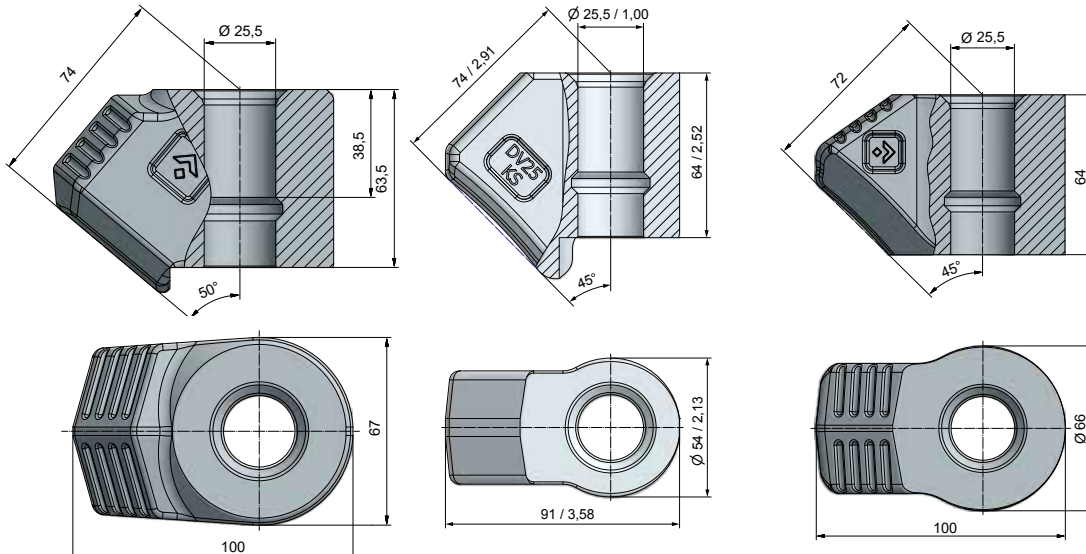

• **BHR186**  
B25.6750 

• **BHR121**  
DV25KS 

• **BHR34**  
DV40VS 

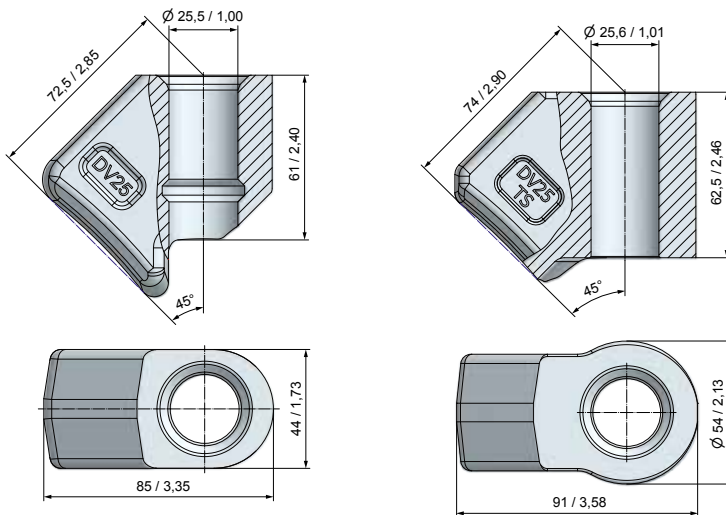

• **BHR31**  
DV25 

• **BHR145**  
DV25TS 

► SHANK SYSTEM – Ø 38/30 MM-1,5/1,18"  
GAUGE 64 MM/2,5"

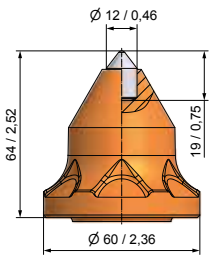

• **BKS165**  
BS38W-12.6064A

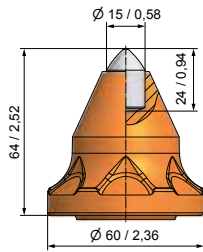

• **BKS144**  
BS38W-15.6064

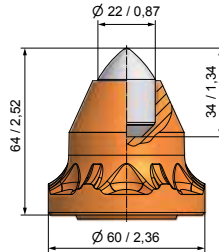

• **BKS162**  
BS38W-22.6064

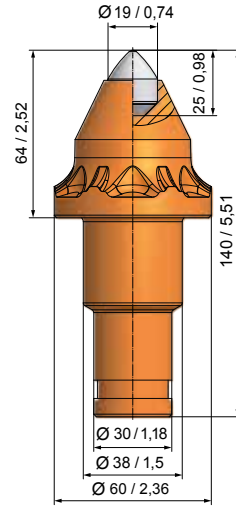

• **BKS151**  
BS38W-19.6064

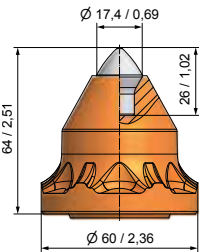

• **BKS163**  
BS38W-70.6064

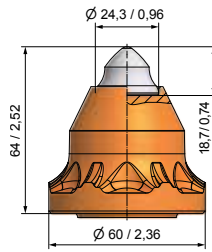

• **BKS160**  
BS38W-68.6064

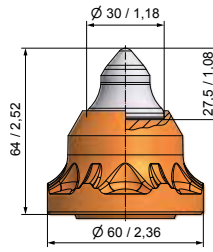

• **BKS161**  
BS38W-69.6064



► SHANK SYSTEM – Ø 38/30 MM-1,5/1,18"  
GAUGE 70 MM/2,75"

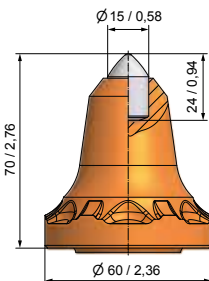

• **BKS168**  
BS38W-15.6070

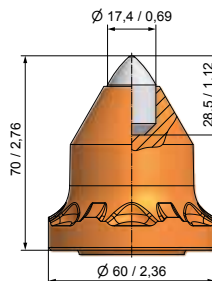

• **BKS166**  
BS38W-17.6070

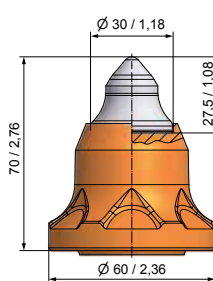

• **BKS167**  
BS38W-69.6070A



# ROUND SHANK CUTTER BITS



## ► SHANK SYSTEM – Ø 38/30 MM-1,5/1,18" GAUGE 77 MM/3,0"

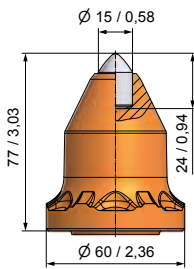

■ **BKS169**  
BS38W-15.6077A

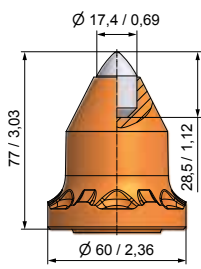

■ **BKS171**  
BS38W-17.6077

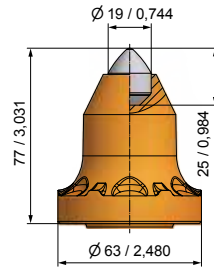

■ **BKS172**  
BS38W-19.6377

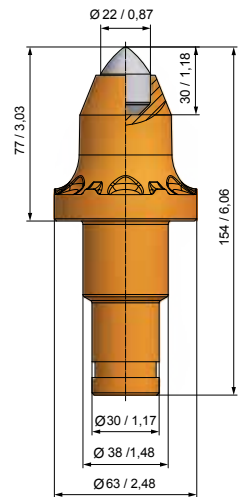

■ **BKS170**  
BS38W-22.6377

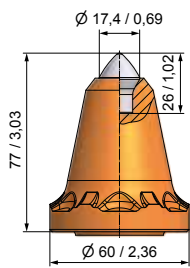

■ **BKS174**  
BS38W-70.6077

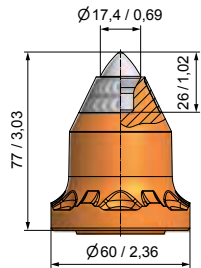

■ **BKS193**  
BS38W-70.6077P

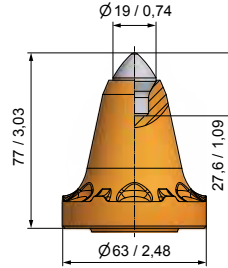

■ **BKS175**  
BS38W-72.6077

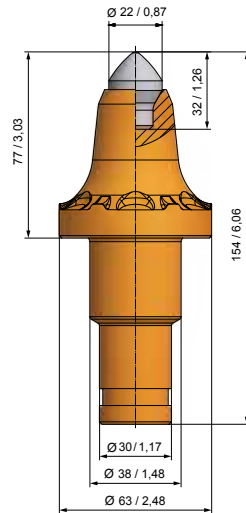

■ **BKS158**  
BS38W-73.6077

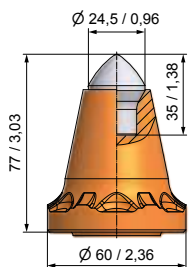

■ **BKS176**  
BS38W-71.6077

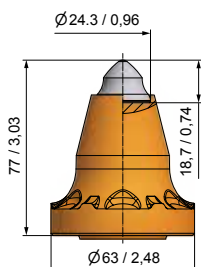

■ **BKS178**  
BS38W-68.6377

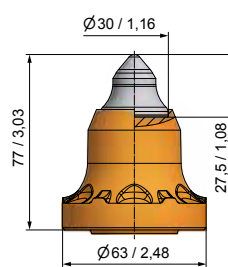

■ **BKS177**  
BS38W-69.6377





► SHANK SYSTEM – Ø 38/30 MM-1,5/1,18" GAUGE 89 MM/3,5"

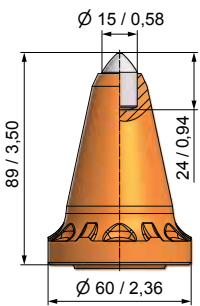

■ **BKS179**  
BS38W-15.6089

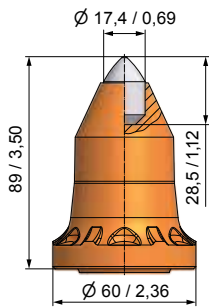

■ **BKS180**  
BS38W-17.6089

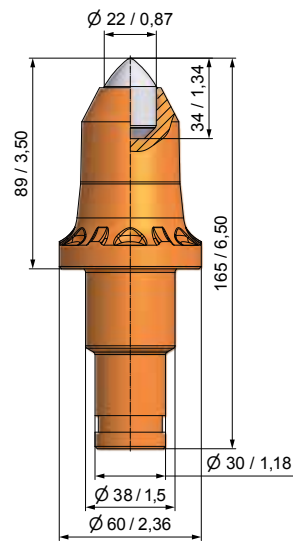

■ **BKS183**  
BS38W-22.6089

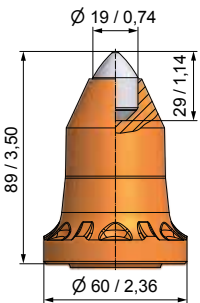

■ **BKS181**  
BS38W-19.6089

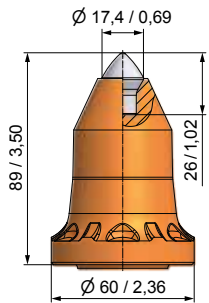

■ **BKS182**  
BS38W-70.6089



# ROUND SHANK CUTTER BITS

► SHANK SYSTEM – Ø 38/30 MM-1,5/1,18"  
GAUGE 77 MM/3,0"

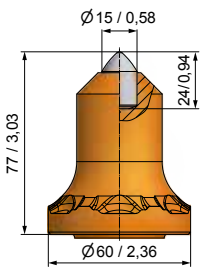

• **BKF32**  
BS38F-15.6077

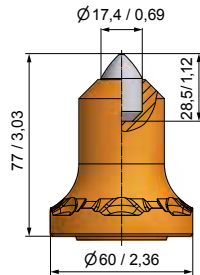

• **BKF33**  
BS38F-17.6077

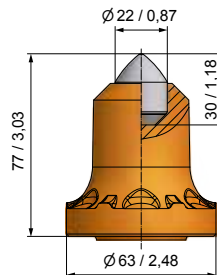

• **BKF31**  
BS38F-22.6377

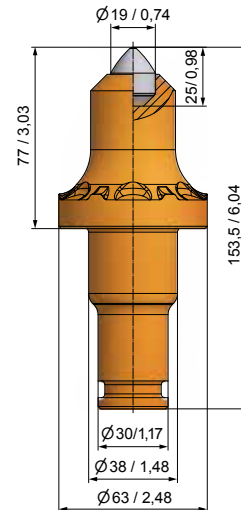

• **BKF30**  
BS38F-19.6377

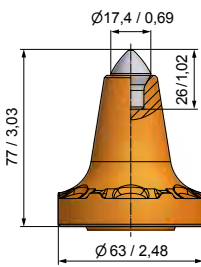

• **BKF40S**  
BS38F-70.6377S

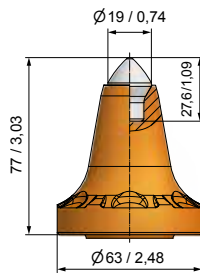

• **BKF39S**  
BS38F-72.6377S

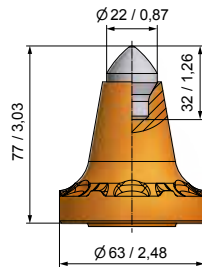

• **BKF38S**  
BS38F-73.6377S

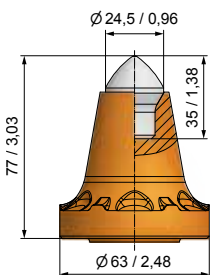

• **BKF36S**  
BS38F-71.6377S

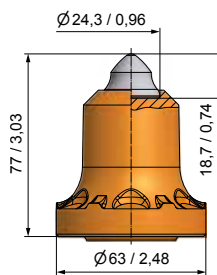

• **BKF34**  
BS38F-68.6377

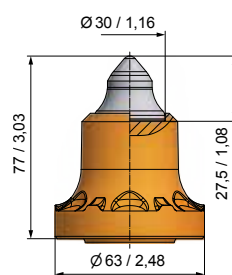

• **BKF37**  
BS38F-69.6377



# ROUND SHANK CUTTER BITS



## ► SHANK SYSTEM – Ø 38/30 MM-1,5/1,18" GAUGE 64/68 MM-2,5/2,68"

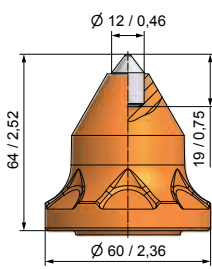

■ **BKF27**  
BS38F-12.6064

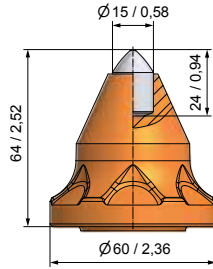

■ **BKF24**  
BS38F-15.6064

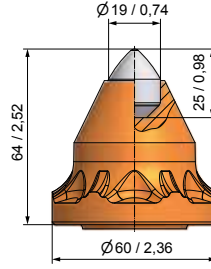

■ **BKF22**  
BS38F-19.6064

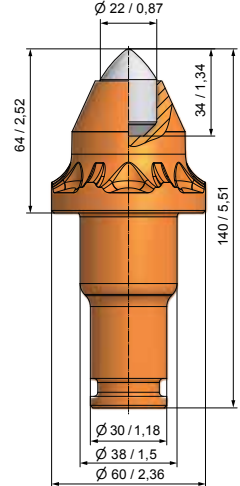

■ **BKF26**  
BS38F-22.6064

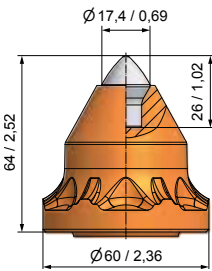

■ **BKF25**  
BS38F-70.6064

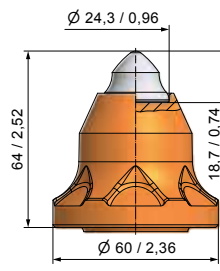

■ **BKF28**  
BS38F-68.6064

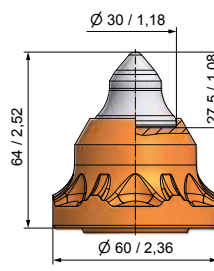

■ **BKF29**  
BS38F-69.6064

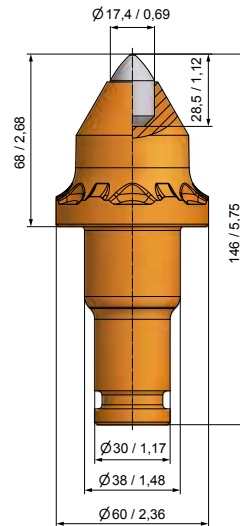

■ **BKF63**  
BS38F-17.6068

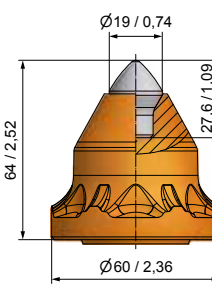

■ **BKF65**  
BS38F-72.6064

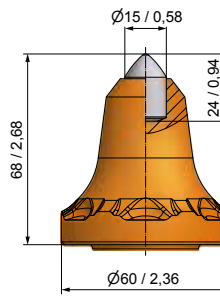

■ **BKF62**  
BS38F-15.6068

► SHANK SYSTEM – Ø 38/30 MM-1,5/1,18" GAUGE 89 MM/3,5"

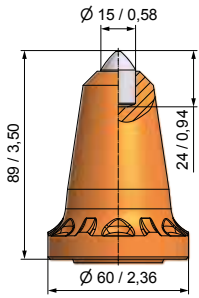

■ **BKF41**  
BS38F-15.6089 

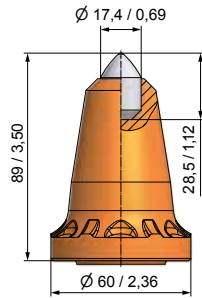

■ **BKF42**  
BS38F-17.6089 

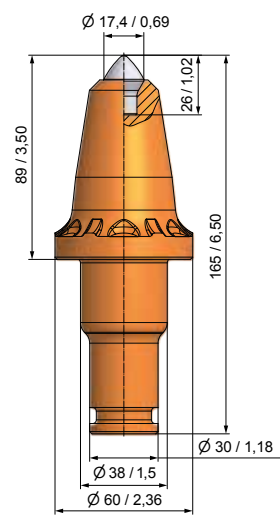

■ **BKF45**  
BS38F-70.6089 

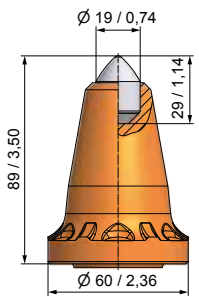

■ **BKF43**  
BS38F-19.6089 

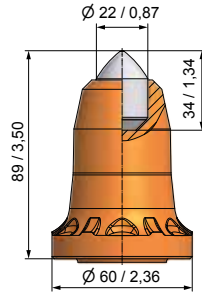

■ **BKF44**  
BS38F-22.6089 





► SHANK SYSTEM – Ø 38/30 MM-1,5/1,18"

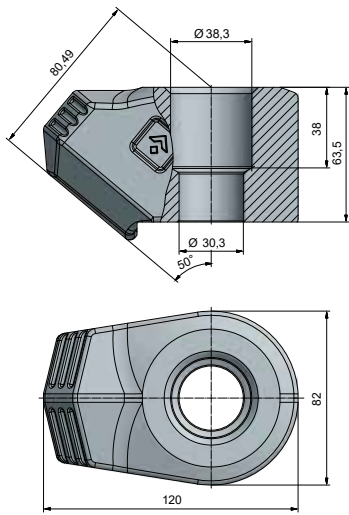

■ **BHR187**  
B3830.8250

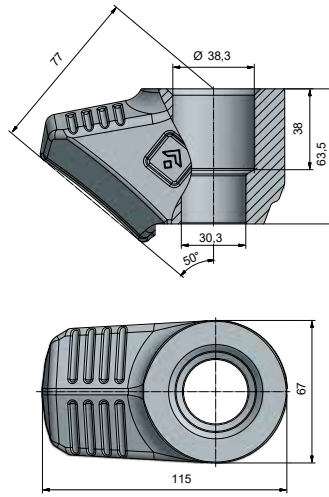

■ **BHR188**  
B3830.6750

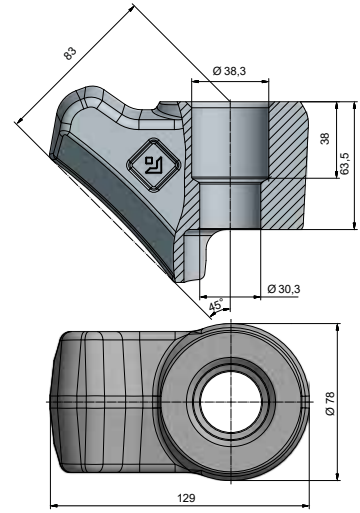

■ **BHR204**  
B3830.7845

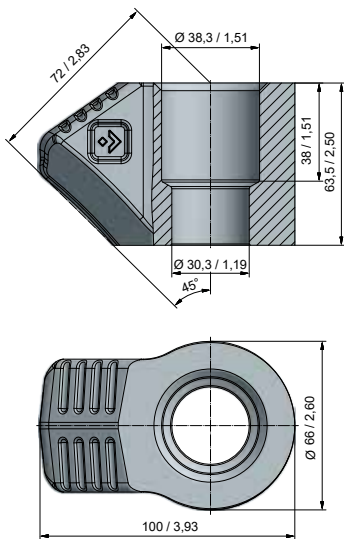

■ **BHR38**  
B43H

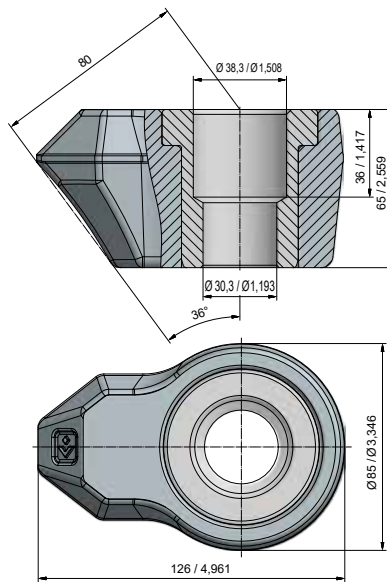

■ **BHR417**  
B3830.8536-B



# ACCESSORIES



■ **BZ44**  
Bit extractor for Mini bit



■ **BZ42**  
Bit extractor for BSH and BC-Series



■ **BZ43**  
Bit extractor for BSH, BC and BSK-Series



■ **BZ38**  
Wedge puller for shaft diameter 20-25

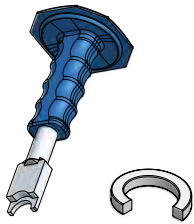

■ **BZ33**  
Assembly tool for SI36

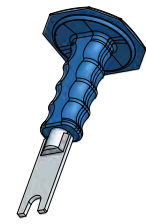

■ **BZ31**  
Disassembly tool for SI36



■ **BZ41**  
Assembly tool for SI26



■ **BZ32**  
Disassembly tool for SI26



■ **BZ22**  
Bit puller for BTK-Series

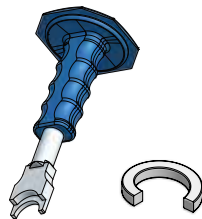

■ **BZ37**  
Assembly tool for SI216



■ **BZ36**  
Disassembly tool for SI216



■ **BZ05**  
Bit puller for head diameter 60

# ACCESSORIES



▪ **BZ35**  
Assembly tool for SI239



▪ **BZ34**  
Disassembly tool for SI239



▪ **BZ39**  
Wedge puller for shaft diameter 30-38



▪ **SRZ02**  
Plier for SR83/1, SR81, SR65, SR61, SR56 and SR54



▪ **BZ12**  
Bit puller for BKH-Series



▪ **BZ18**  
Bit puller with copper disk for BKH-Series



▪ **BZ16**  
Bit extractor for Roll pin with diameter 10



▪ **BZ30**  
Bit extractor for Roll pin with diameter 16



▪ **BZ40**  
Wedge puller for stepshank 43/35

# FLEXIBLE WEAR PROTECTION

## › BeCoat® HARDFACING TYPES

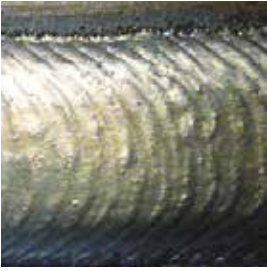

FeCr  
hardfacing



NiCr + FTC  
hardfacing



TC grit  
hardfacing

## › BeCoat® ADVANTAGES

- Cost reduction due to less downtime
- Coating thickness ≤ 6mm
- Evenly distributed fused tungsten carbide (FTC) and low dilution
- Engineering and consulting
- Proven to withstand even the harshest environments

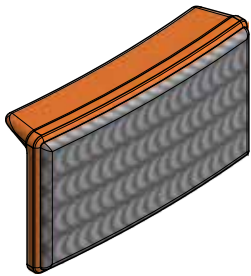

▪ **BA73**  
BA 72x40x17

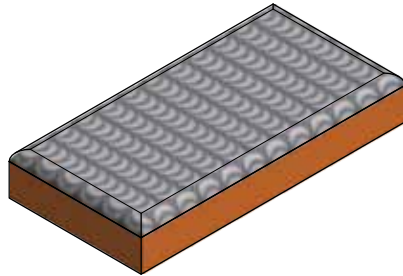

▪ **BBM386**  
BBM 100x50x16

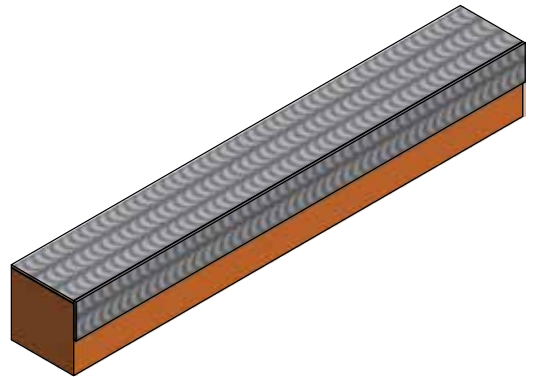

▪ **BBM391**  
BBM 180x26x26





# EXTENSIVE WEAR PROTECTION



## ► OVERVIEW

Betek can provide the appropriate stud welding machine for the TungStuds wear protection system.

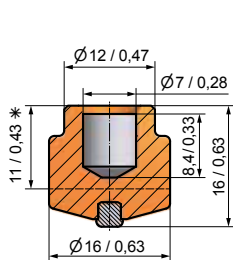

■ **BTS01** BTSD16/16

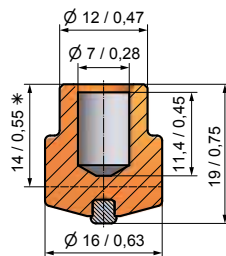

■ **BTS02** BTSD16/19

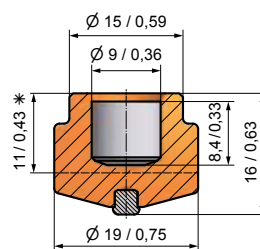

■ **BTS03** BTSD19/16

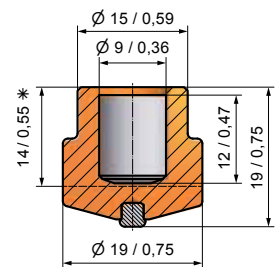

■ **BTS04** BTSD19/19

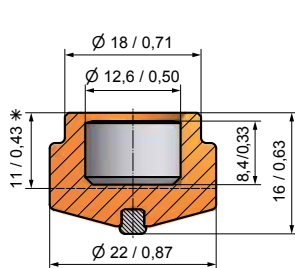

■ **BTS05** BTSD22/16

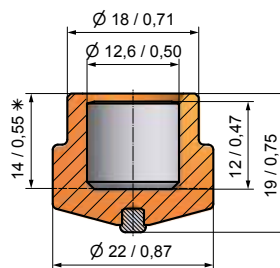

■ **BTS06** BTSD22/19

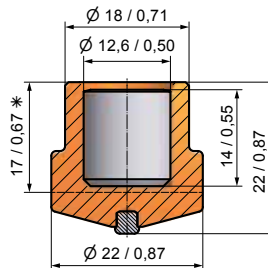

■ **BTS07** BTSD22/22

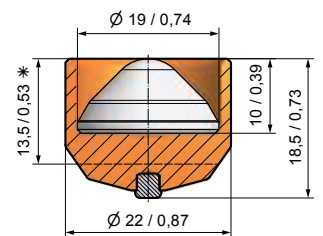

■ **BTS08** BTSD22/18,5SG

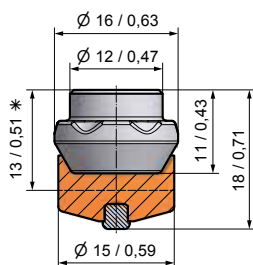

■ **BTS10B** BTSD16/18B

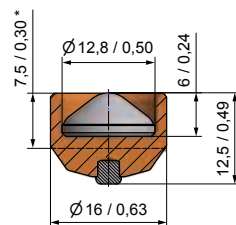

■ **BTS20** BTSD16/12,5SG

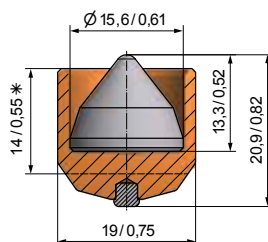

■ **BTS100** BTSD19/15,6SG



\*Height after welding

## ➤ BTS-PLATES

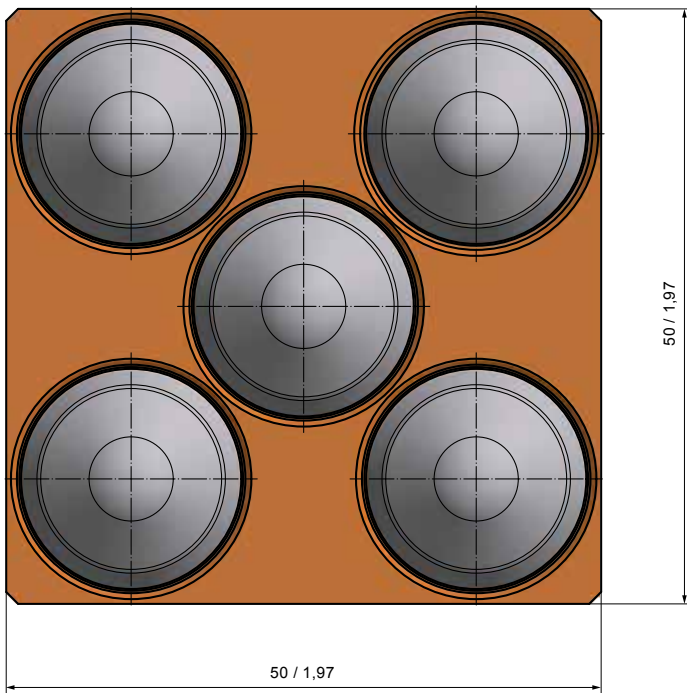
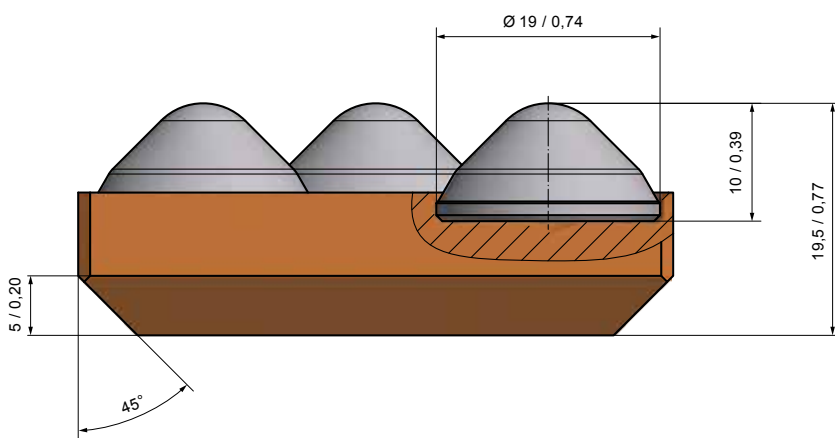

### DIMENSIONS

Width in mm	Length in mm
50	50
75	75
100	100
125	125
150	150

Other sizes on request

# EXTENSIVE WEAR PROTECTION

## > WELDING PROCESS

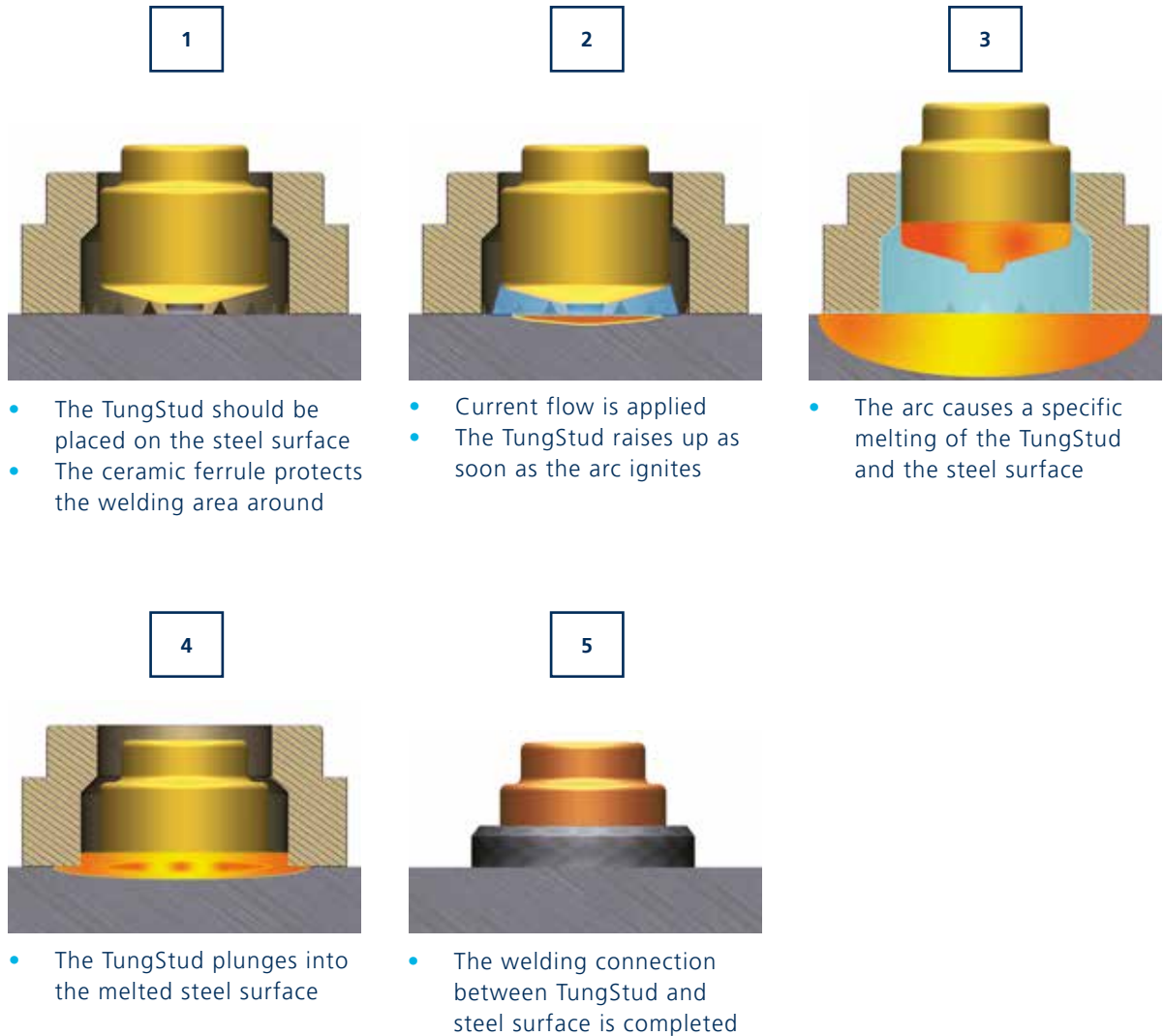

### BENEFITS

- Wear resistant thanks to the carbide core
- Quick welding process
- Suitable for uneven surfaces
- Simply replaceable
- Less maintenance > Higher productivity
- Less downtime > Cost reduction



# PERFORMANCE

## › CUTTING WEAR PROTECTION

---

- Grid pattern is recommended
- Cutting wear protection due to the conical carbide shape

### EXTENSIVE WEAR PROTECTION



## › ROCK BOX EFFECT

---

- Grid pattern is recommended
- Rock-Box-Effect due to the cylindrical carbide shape

### EXTENSIVE WEAR PROTECTION

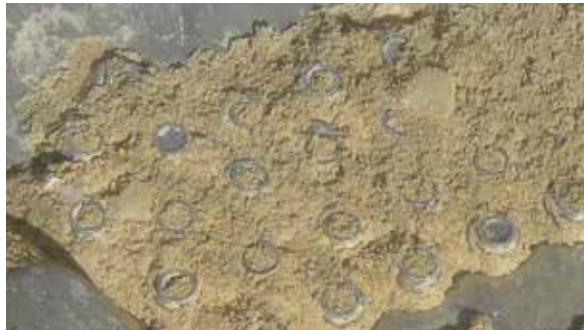

# APPLICATION

---









# ➤ BETEK



## SURFACE TECHNOLOGIES

- ROAD MILLING
- SURFACE MINING
- STABILISING



## UNDERGROUND TECHNOLOGIES

- FOUNDATION DRILLING
- MINING
- TRENCHLESS
- TRENCHING
- TUNGSTUDS
- DRUM CUTTERS

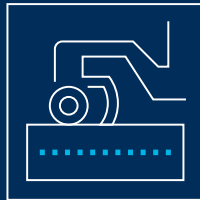

## ENVIRONMENTAL TECHNOLOGIES

- AGRICULTURE
- GRADER TOOLS
- FORESTRY & RECYCLING



## INDUSTRIAL TECHNOLOGIES

- CRUSHING & MIXING
- TUNGSTEN CARBIDE
- RAIL TRACK CONSTRUCTION
- INDUSTRIAL SOLUTIONS

Service number  
+49 (0) 7422. 565-0

info@betek.de  
[www.betek.de](http://www.betek.de)